



# M902TA

Rising Sun Series -- 2835 SMD LED Module

Available in ● ○

## Product Features

The M902TA is powered by a 2835 SMD LED chip, designed to produce high luminous efficacy. Built with overmolded housing and aluminum PCB, the M902TA was designed to last. Printed markings allow individual modules to be cut, while double-sided 3M adhesive tape found on the back of modules allows for easy installation.

## Product Specifications

	Model No.	M902TA
Physical	Color	White
	Dimensions (length x width x height)	1.77" x 0.51" x 0.37"
	Color Temperature	6000K
	LED Chips / Module	2
	LED Modules / Foot	2
	LED Modules / String	25
	Operating Temperature	-13 ~ 140 °F
	Storage Temperature	-13 ~ 158 °F
	View Angle	160°
Electrical	Power Consumption	0.72 W
	Forward Voltage	12V
	Forward Current	60 mA
Output	Lumens / Module	70
	Lumens / Foot	140
Safety	Certification	UL, CE, RoHS
	Ingress Grade	IP65
	Warranty	4 years or 18,000 hours

## Color Variations

		Red
Physical	Color Temperature	620-625K
	CRI	
Electrical	Lumens / Module	18
	Lumens / Foot	32

## Product Dimensions

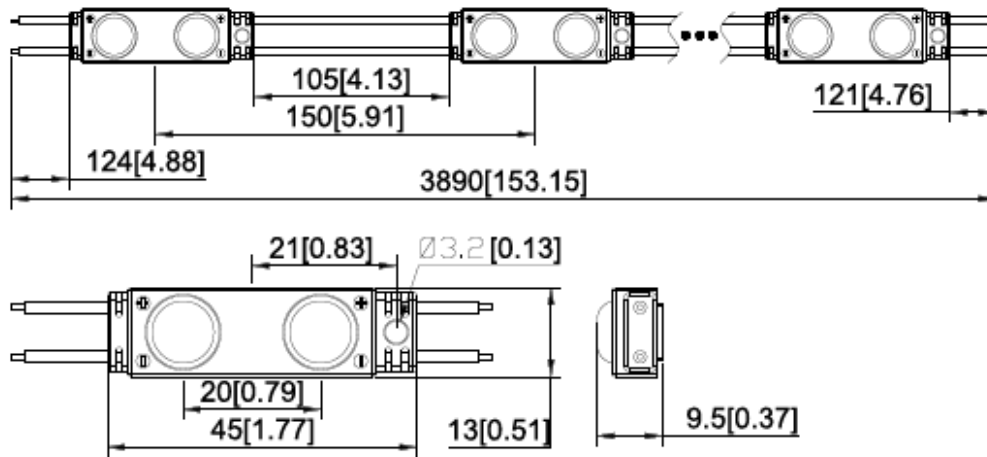

Units: mm [in]

## Light Distribution

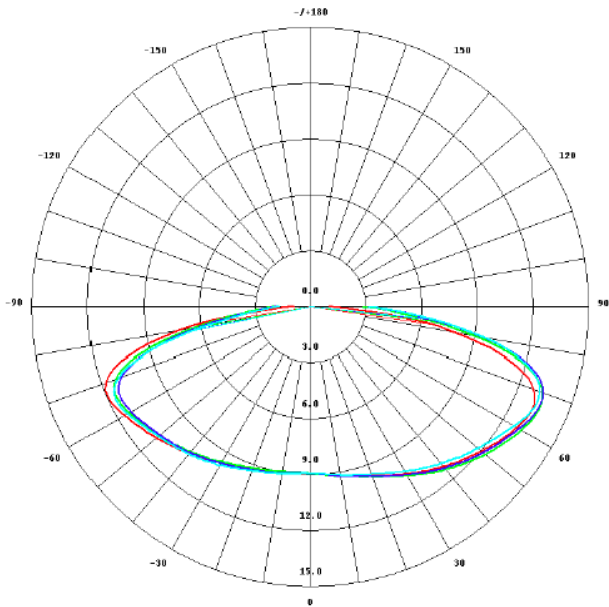

## Packaging Information

25 modules per string

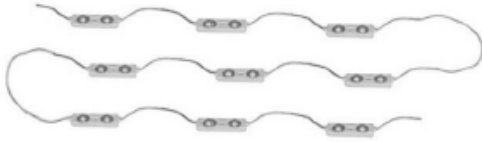

4 strings per plate

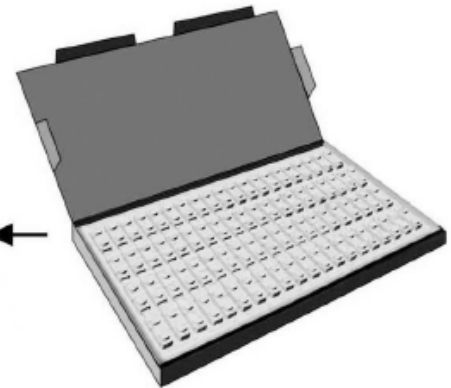
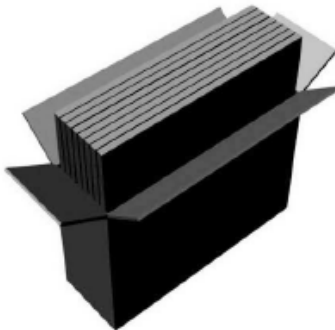
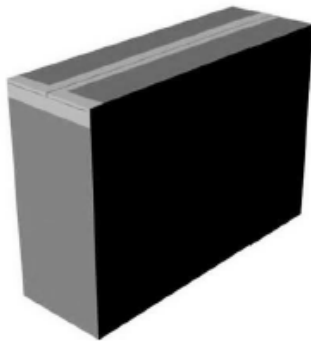
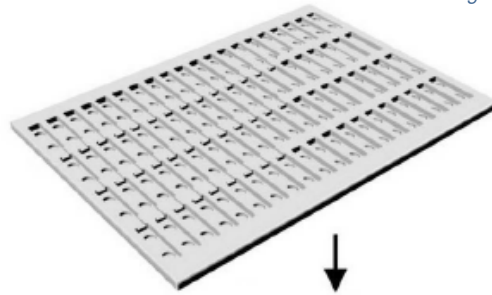

10 cartons per package

1 plate per carton

## Packaging Dimensions ( subject to change without prior notice )

Weight (per module)	8.1 g	0.018 lb
Package Dimensions (length x width x height)	20.47" x 12.59" x 15.35"	
Net Weight	18.52 lb	
Gross Weight	27.99 lb	