



M902TB

Rising Sun Series -- 2835 SMD LED Module

Available in ● ○

Product Features

The M902TB is powered by a 2835 SMD LED chip, designed to produce high luminous efficacy. Built with overmolded housing and aluminum PCB, the M902TB was designed to last. Printed markings allow individual modules to be cut, while double-sided 3M adhesive tape found on the back of modules allows for easy installation.

Product Specifications

	Model No.	M902TB
Physical	Color	White
	Dimensions (length x width x height)	1.77" x 0.51" x 0.37"
	Color Temperature	6000K
	LED Chips / Module	2
	LED Modules / Foot	2
	LED Modules / String	50
	Operating Temperature	-13 ~ 140 °F
	Storage Temperature	-13 ~ 158 °F
	View Angle	160°
Electrical	Power Consumption	0.72 W
	Foward Voltage	12V
	Forward Current	60 mA
Output	Lumens / Module	70
	Lumens / Foot	140
Safety	Certification	UL, CE, RoHS
	Ingress Grade	IP65
	Warranty	5 years or 22,000 hours

Color Variations

		Red
Physical	Color Temperature	620-625K
	CRI	
Electrical	Lumens / Module	13
	Lumens / Foot	26

Product Dimensions

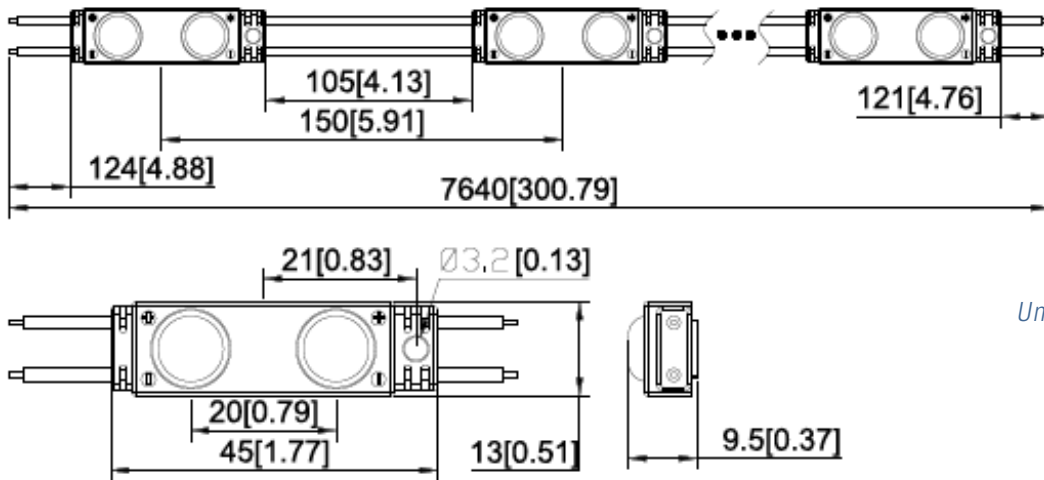

Units: mm [in]

Light Distribution

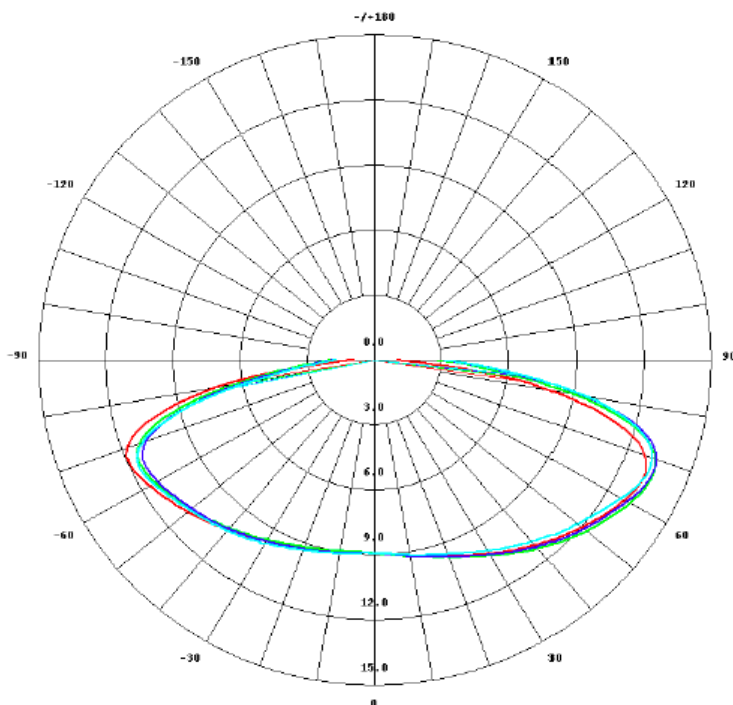

Packaging Information

50 modules per string

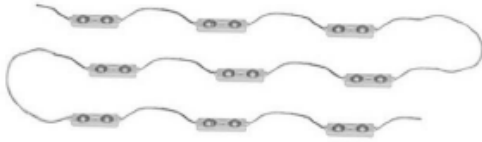

2 strings per plate

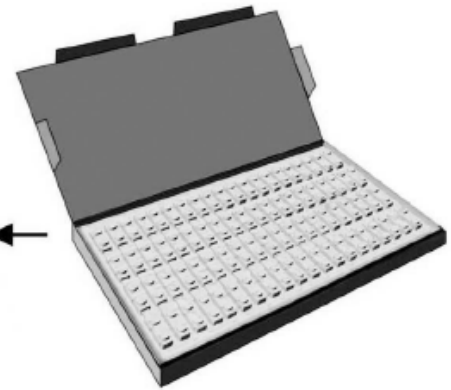
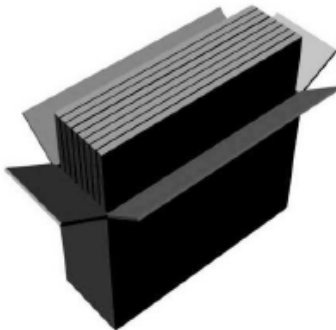
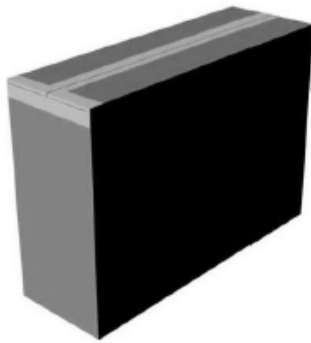
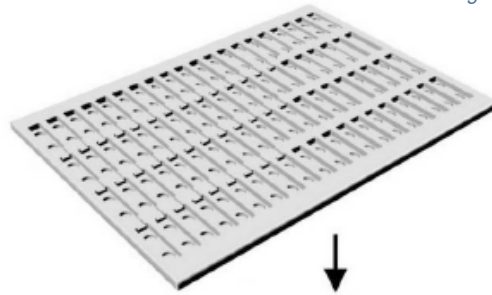

10 cartons per package

1 plate per carton

Packaging Dimensions (subject to change without prior notice)

Weight (per module)	8.1 g	0.018 lb
Package Dimensions (length x width x height)	20.47" x 12.59" x 15.35"	
Net Weight	18.52 lb	
Gross Weight	27.99 lb	