



M903TB - 1.2 W

Rising Sun Series -- 2835 SMD LED Module

Available in ● ○

Product Features

The M903TB is powered by a 2835 SMD LED chip, designed to produce high luminous efficacy. Built with overmolded housing and aluminum PCB, the M903TB was designed to last. Printed markings allow individual modules to be cut, while double-sided 3M adhesive tape found on the back of modules allows for easy installation.

Product Specifications

	Model No.	M903TB
Physical	Color	White
	Dimensions (length x width x height)	2.68" x 0.51" x 0.36"
	Color Temperature	6000K
	LED Chips / Module	3
	LED Modules / Foot	2
	LED Modules / String	25
	Operating Temperature	-13 ~ 140 °F
	Storage Temperature	-13 ~ 158 °F
	View Angle	160°
Electrical	Power Consumption	1.2 W
	Foward Voltage	12V
	Forward Current	100 mA
Output	Lumens / Module	106
	Lumens / Foot	212
Safety	Certification	UL, CE, RoHS
	Ingress Grade	IP65
	Warranty	5 years or 22,000 hours

Color Variations

		Red
Physical	Color Temperature	620-625K
	CRI	
Electrical	Lumens / Module	30
	Lumens / Foot	60

Product Dimensions

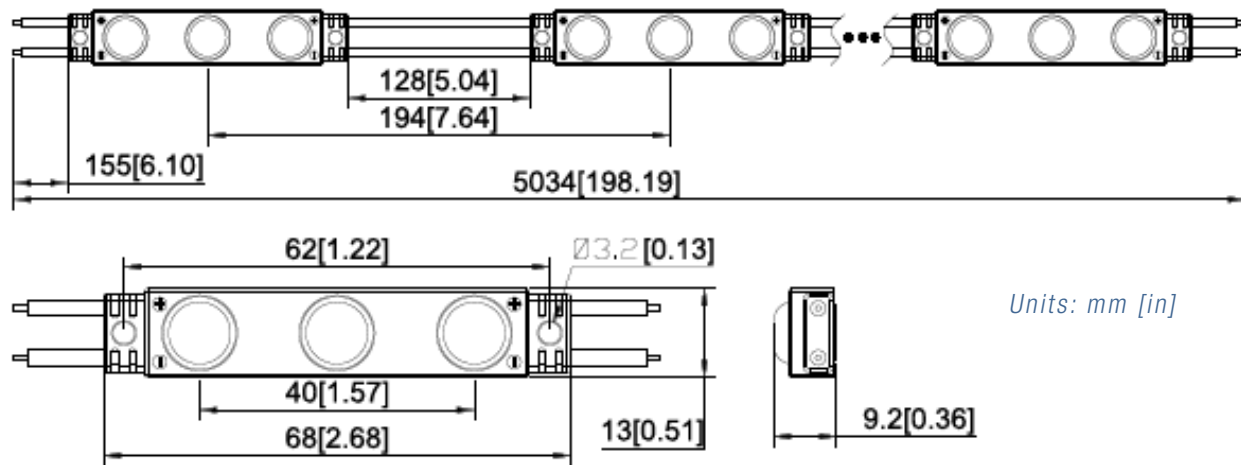

Light Distribution

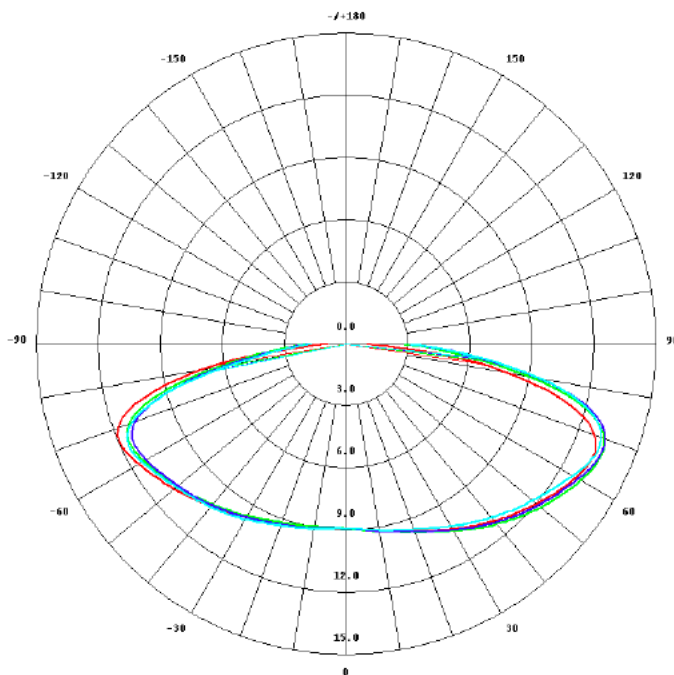

Packaging Information

25 modules per string

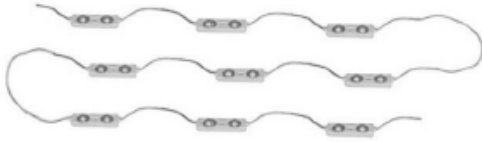

4 strings per plate

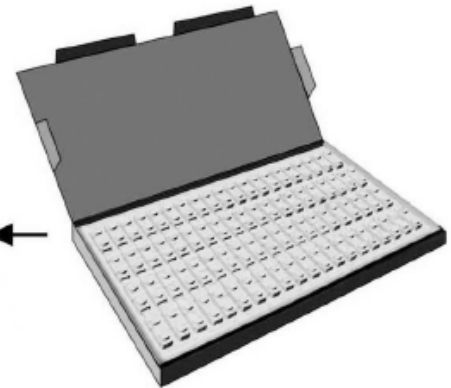
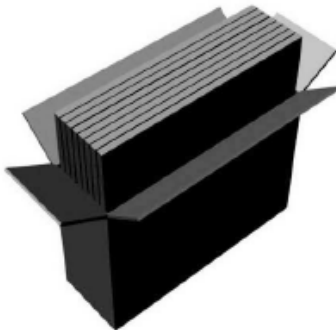
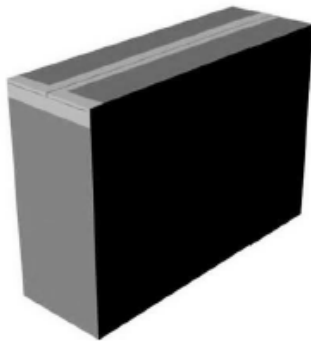
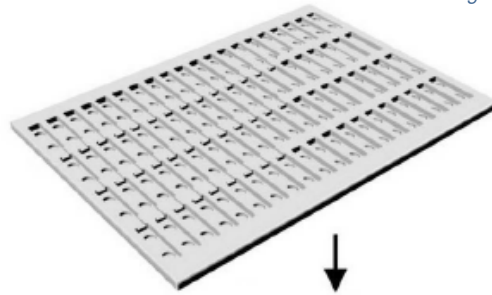

10 cartons per package

1 plate per carton

Packaging Dimensions (subject to change without prior notice)

Weight (per module)	10.2 g	0.022 lb
Package Dimensions (length x width x height)	20.47" x 12.59" x 15.35"	
Net Weight	22.92 lb	
Gross Weight	33.51 lb	